

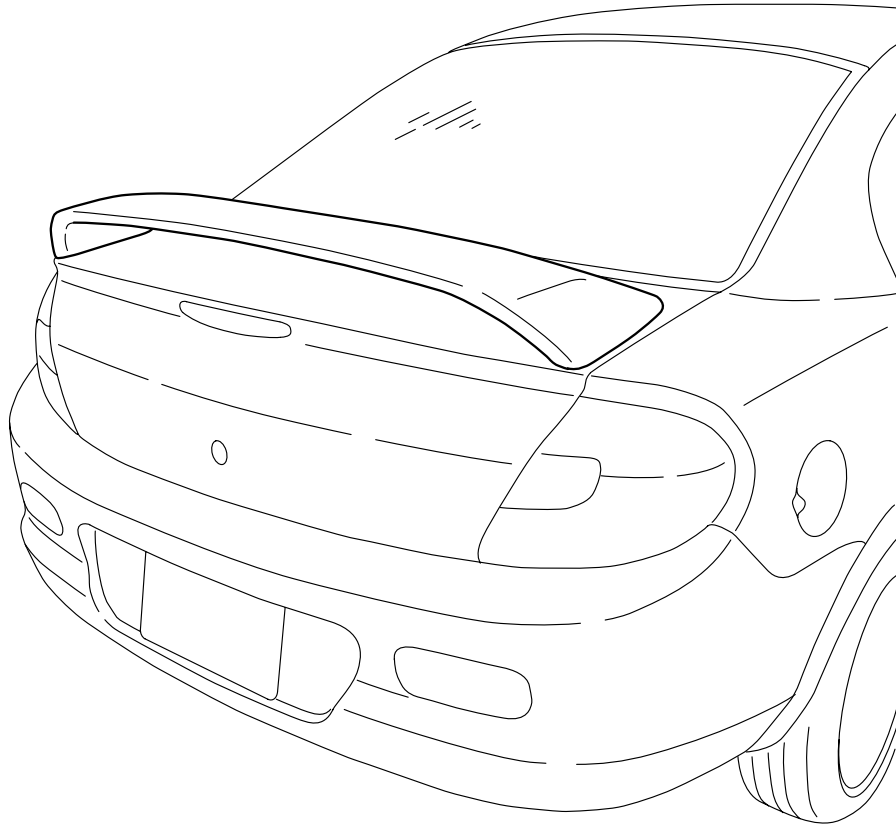

# Mopar

**PARTS**

© DAIMLERCHRYSLER



**A**

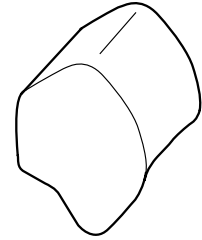

**B** 2x

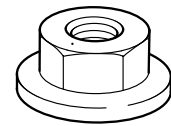

**C** 4x

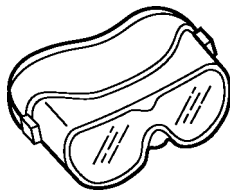
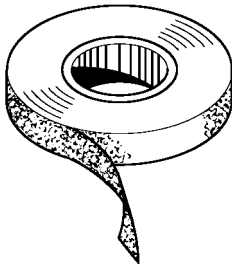
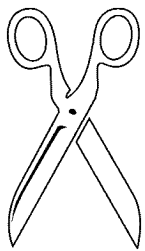

1/8" (3.2mm)



1/4" (7mm)

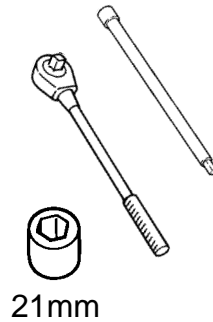
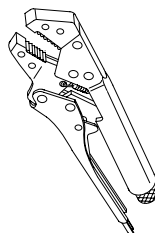
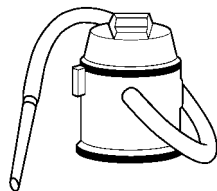
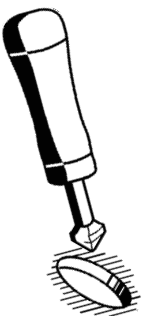
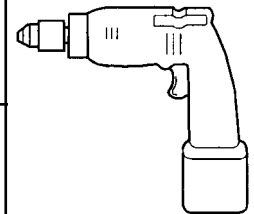

21mm

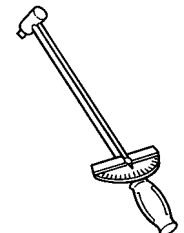

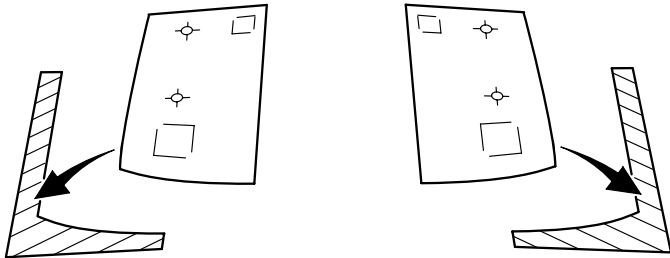
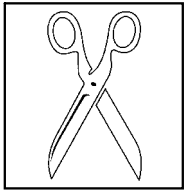

1

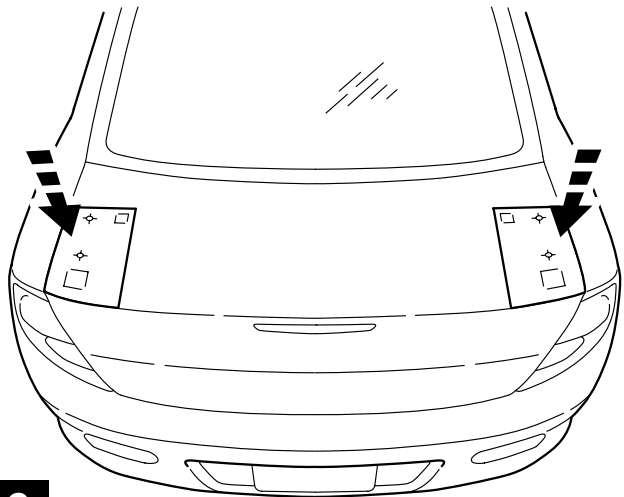

2

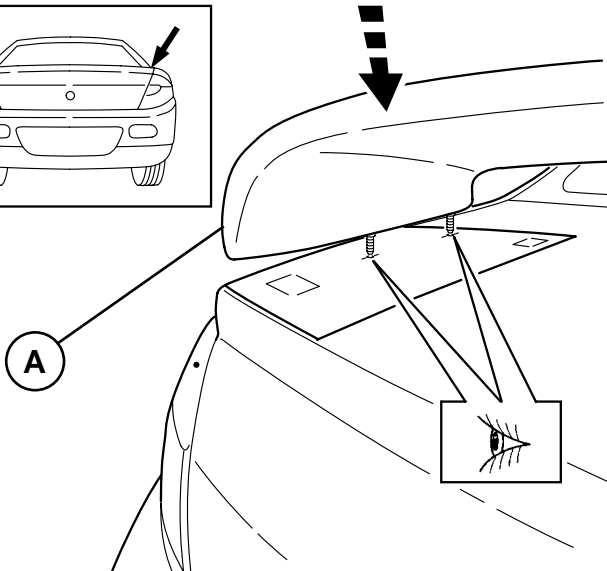
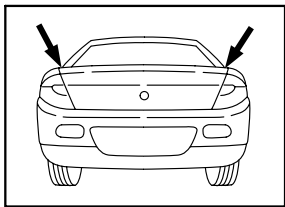

3

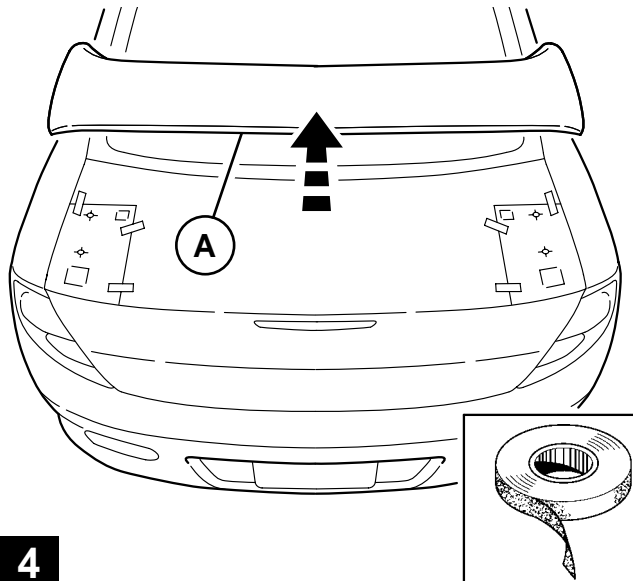

4

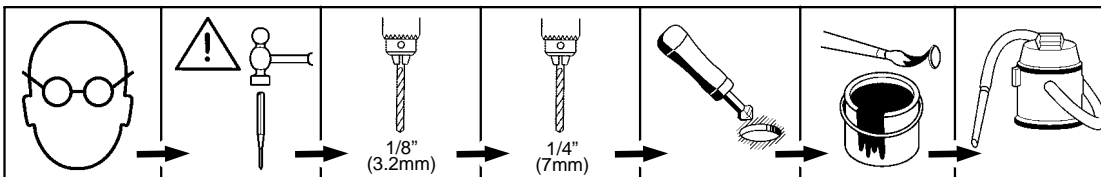

5

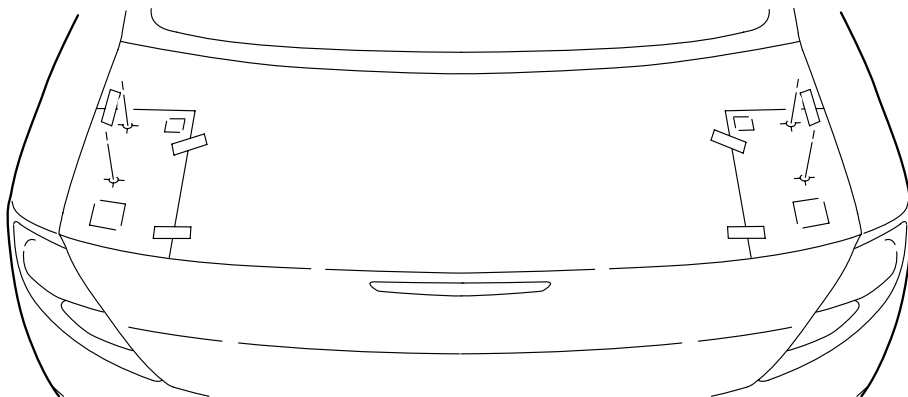

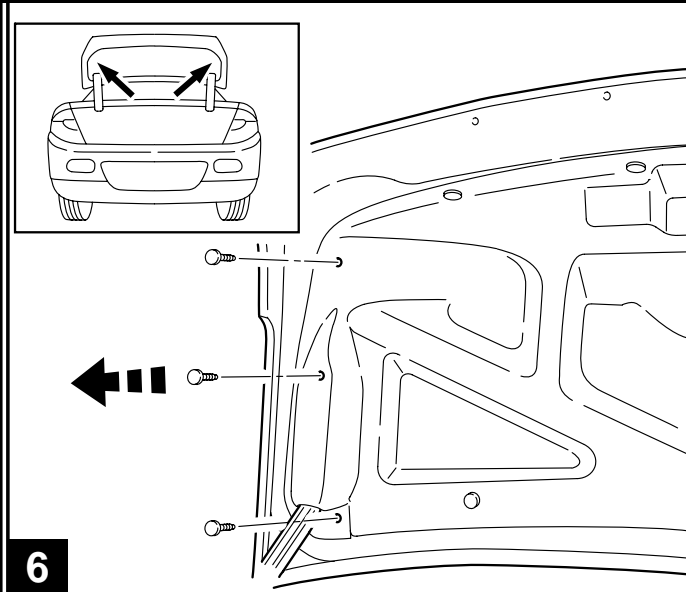

6

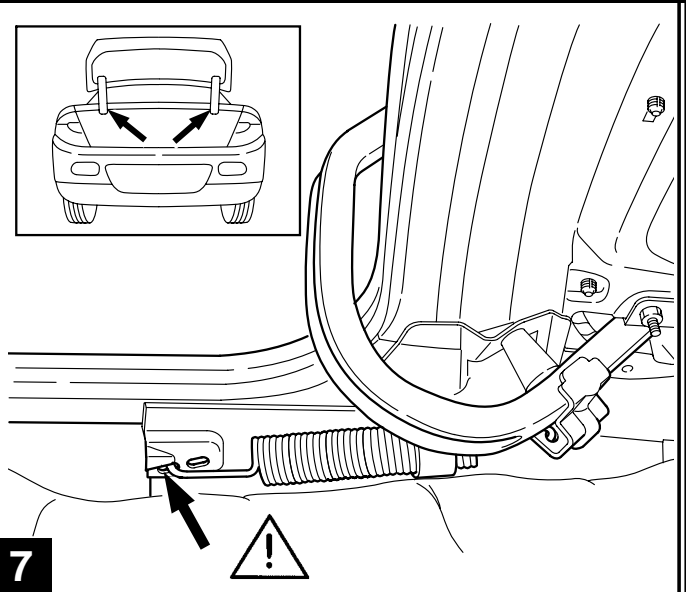

7

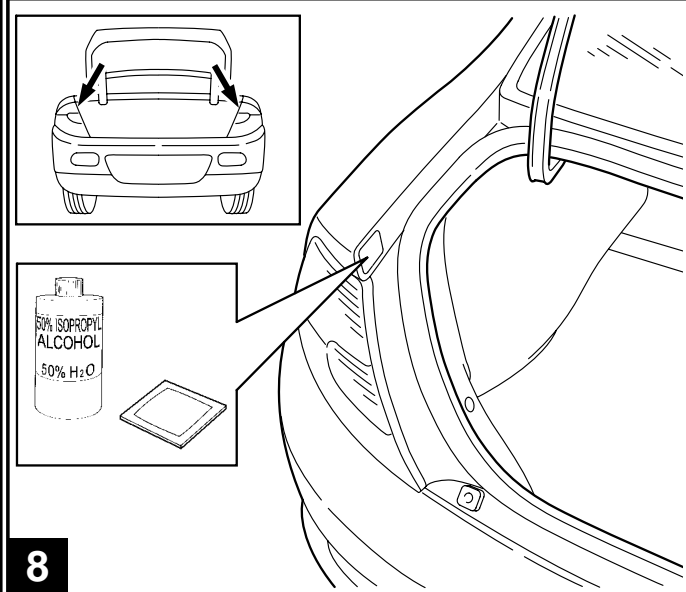

8

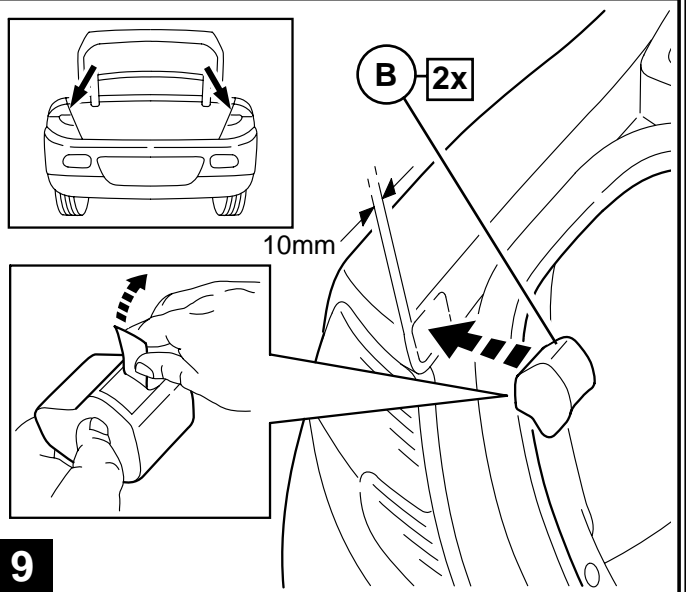

9

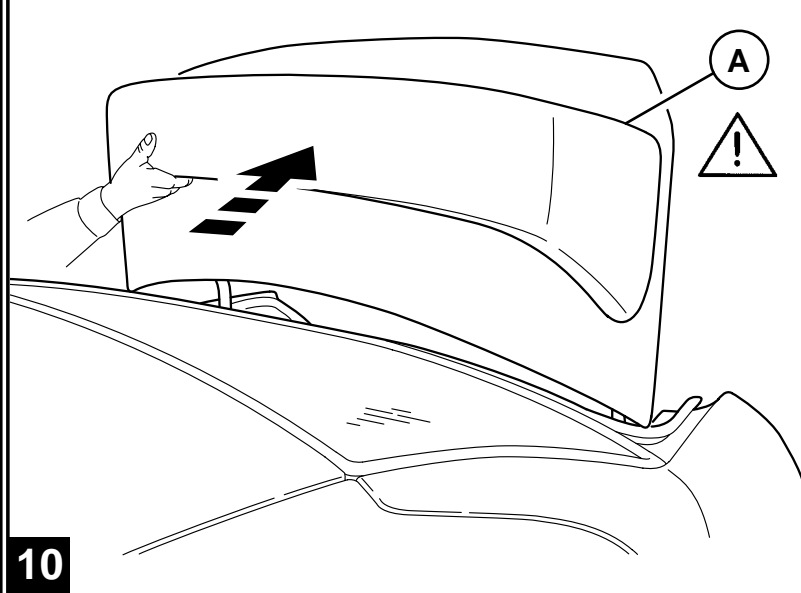

10

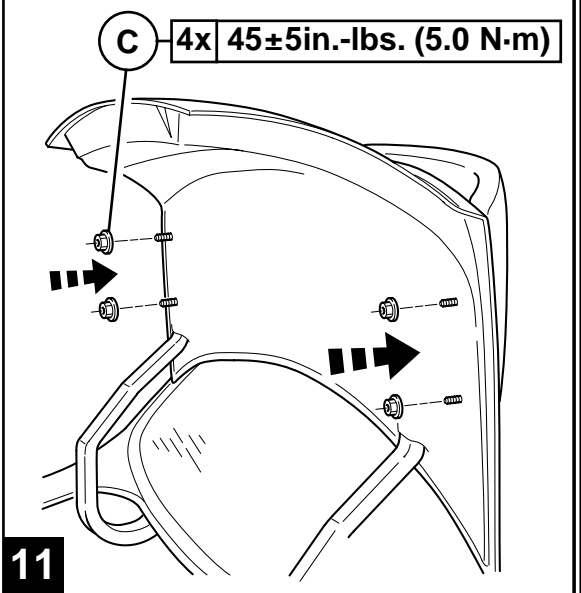

11

**THIS PAGE  
INTENTIONALLY LEFT BLANK**

**1:1**

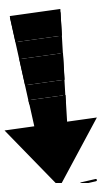
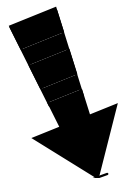
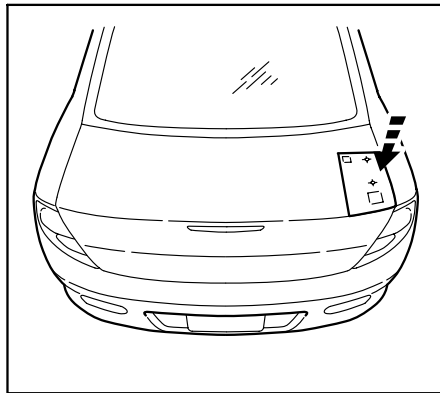
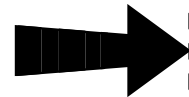
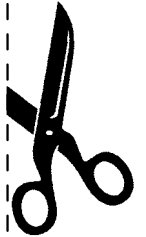
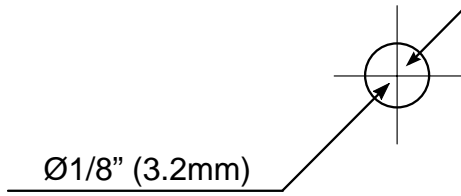
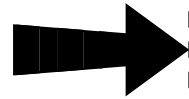
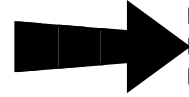
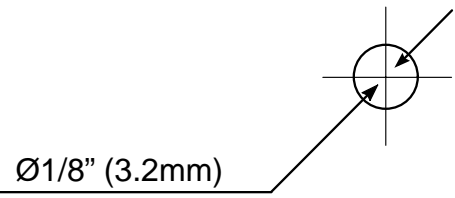

**NOTE TO PRINTER:**

**EACH TEMPLATE MUST BE PRINTED  
ON ITS OWN PAGE. BACKS OF THE  
TEMPLATE PAGES MUST BE BLANK.**

**1:1**

